

Model 587 Turbo /15

HIGH-SPEED AIRFLOW FOR COOLING & HEATING

FEATURES AND BENEFITS

- Reliable Belt-Driven Performance
- Increase Pressure By Up To 98 mbar
- Extremely Energy Efficient
- High-Strength Industrial Design
- Compact Footprint For Easy Installation
- Very Low Maintenance



Product supplied may differ from image based on pressure requirements. Image represents Model 587 Turbo High Velocity Blower.

	587 TURBO
Motor	15 kW
Weight	210 kg
Phase	3
Noise level*	85 dB(A)
Voltage	380 V - 480 V
Frequency	50 / 60 Hz
Run current	23.1 A

*Noise levels have been measured at a distance of 1m from the blower.



BLOWERS - HIGH VELOCITY

PERFORMANCE CURVE

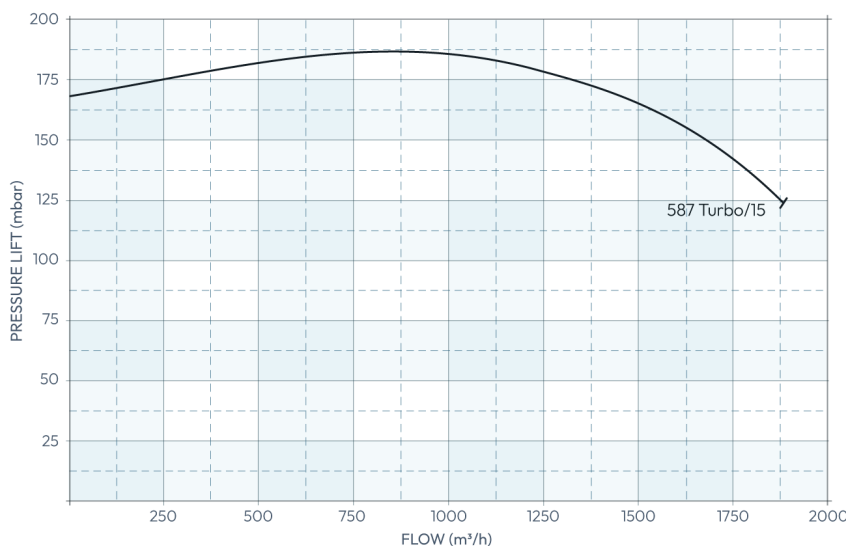

Model 587 Turbo

DIMENSIONAL DRAWING

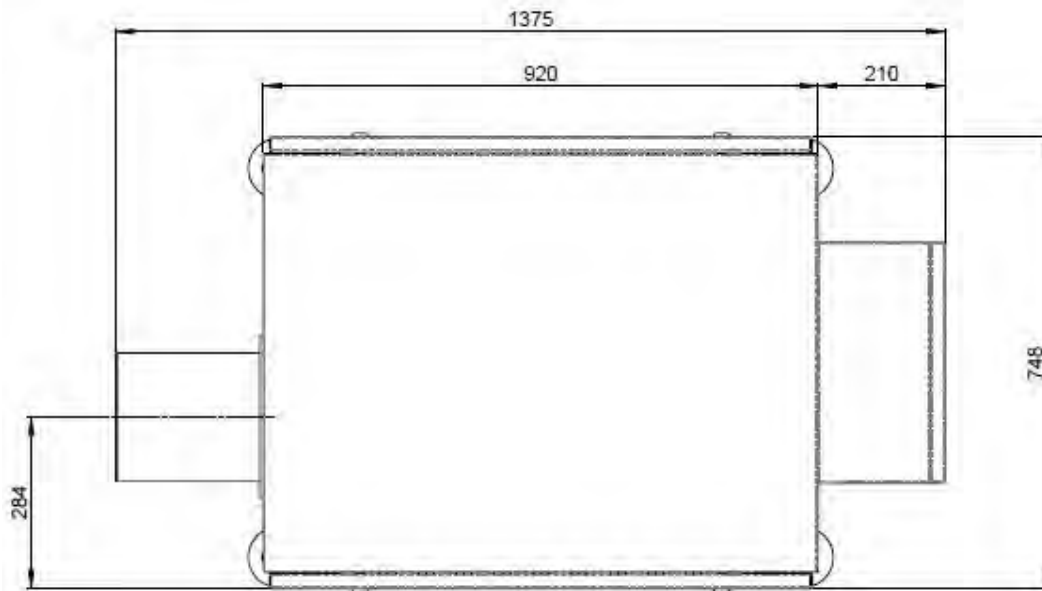
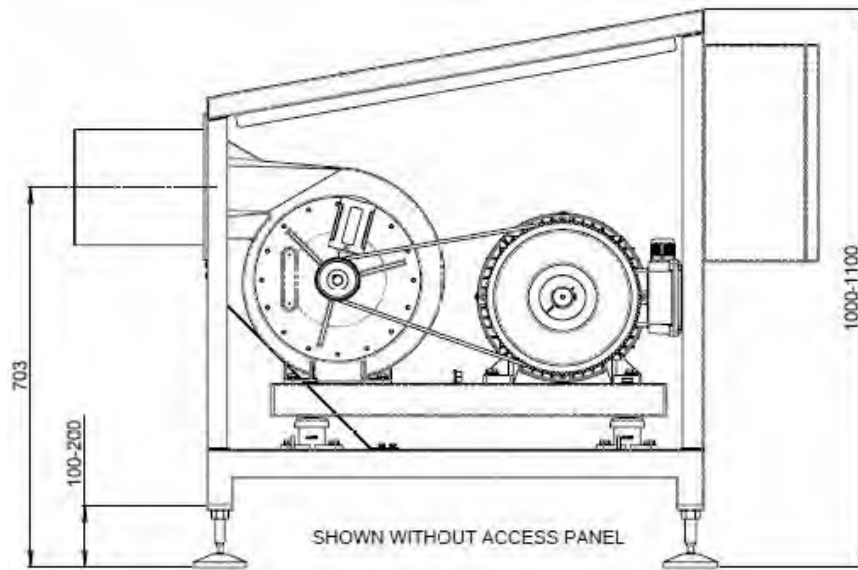

BLOWERS - HIGH VELOCITY

All dimensions in mm