

Model 580/1

HIGH-SPEED AIRFLOW FOR COOLING & HEATING

FEATURES AND BENEFITS

- Reliable Belt-Driven Performance
- Increase Pressure By Up To 78 mbar
- Extremely Energy Efficient
- High-Strength Industrial Design
- Compact Footprint For Easy Installation
- Very Low Maintenance



Product supplied may differ from image based on pressure requirements. Image represents Model 580 High Velocity Blower.

	580/1
Motor	2.2 kW
Weight	43 kg
Phase	3
Noise level*	80 dB(A)
Voltage	380 V - 480 V
Frequency	50 / 60 Hz
Run current	4.7 A

*Noise levels have been measured at a distance of 1m from the blower.

BLOWERS - HIGH VELOCITY

PERFORMANCE CURVE

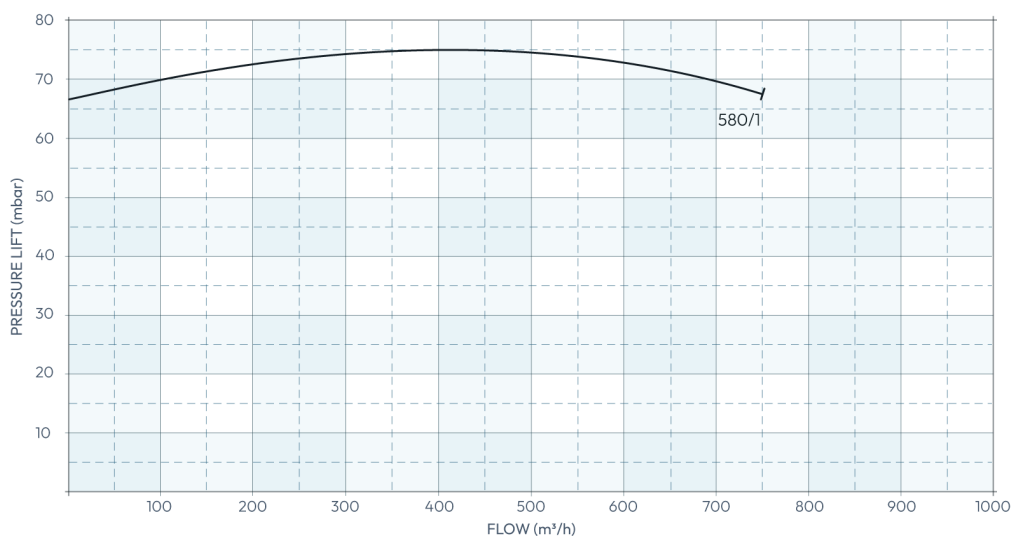

Model 580/1

DIMENSIONAL DRAWING

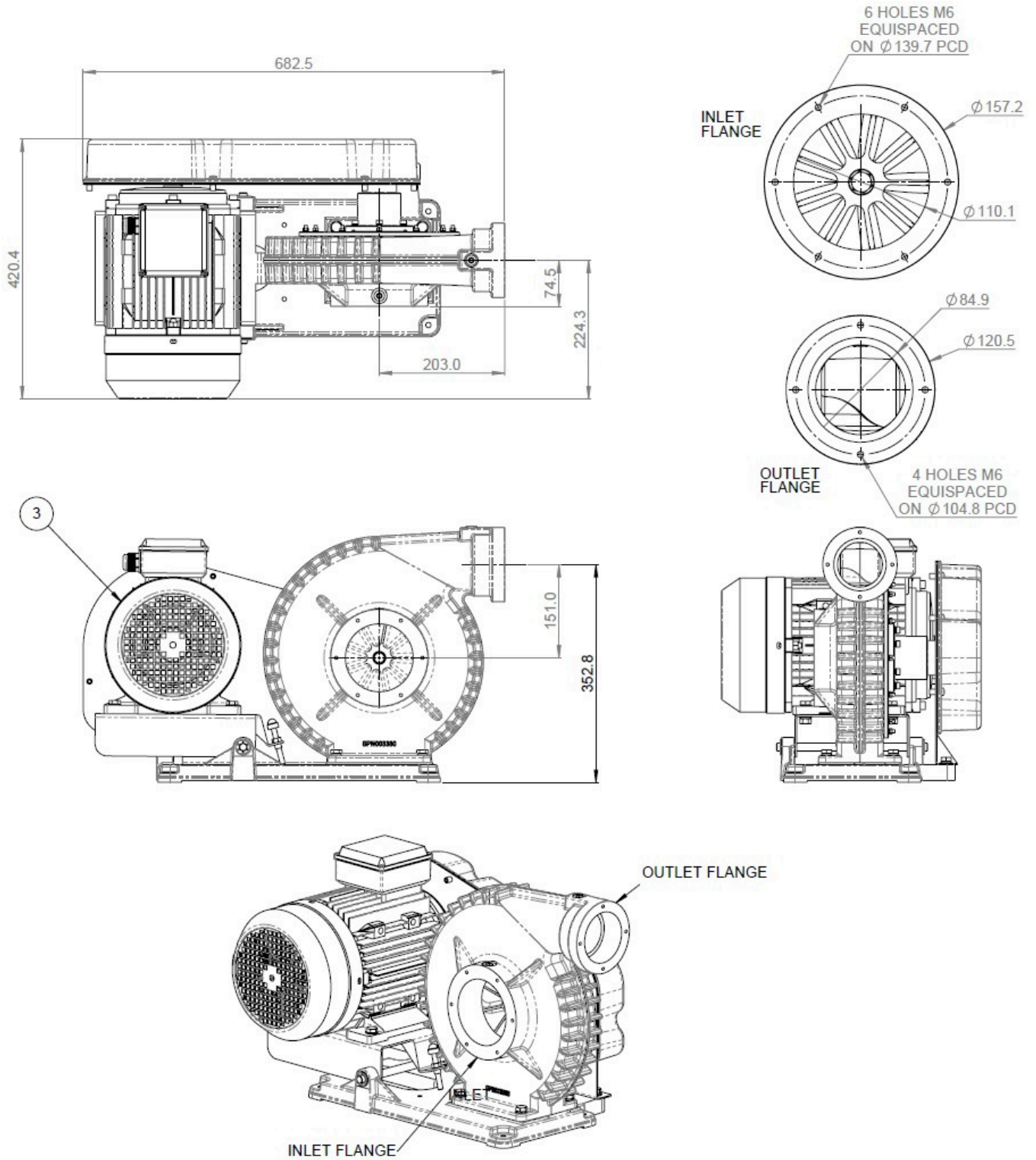

All dimensions in mm

BLOWERS - HIGH VELOCITY